

# Curtain ( Strip ) Sensor

LK-20HM2 2 Beams (57cm long)

LK-20HM4 4 Beams (93cm long)

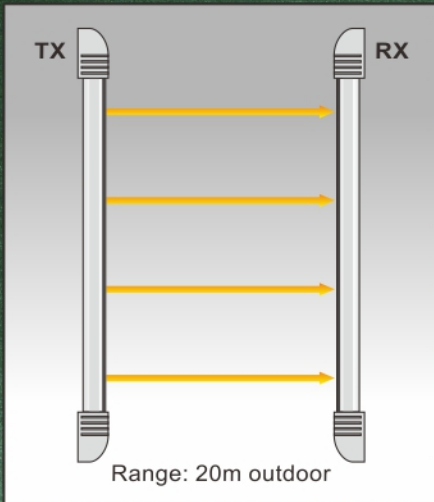

## Applications:

- Indoor/outdoor perimeter security system.
- Install in windows, doorways, skylights, garages, gates, and space where space is limited.

## Features:

- Compact & slim type 35 mm.
- Rugged aluminum construction.
- Water proof IP66 construction.
- Automatic response time control.
- Built in beam alignment LED indicator.
- Built in beam alignment buzzer (beep sound).
- Three levels transmitter IR power setting, according to the distance requirement.
- No synchronizing wire required.
- Swivel body unit, easy installation on window frame & porch.

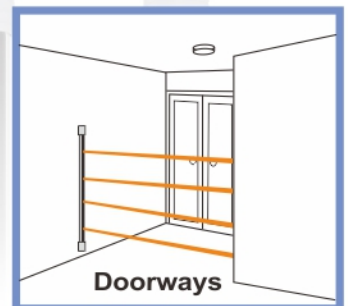
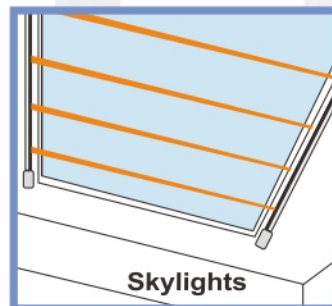
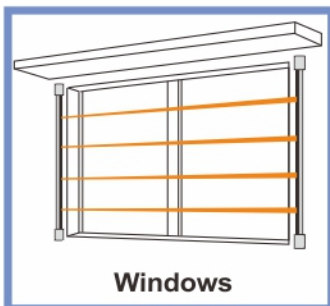
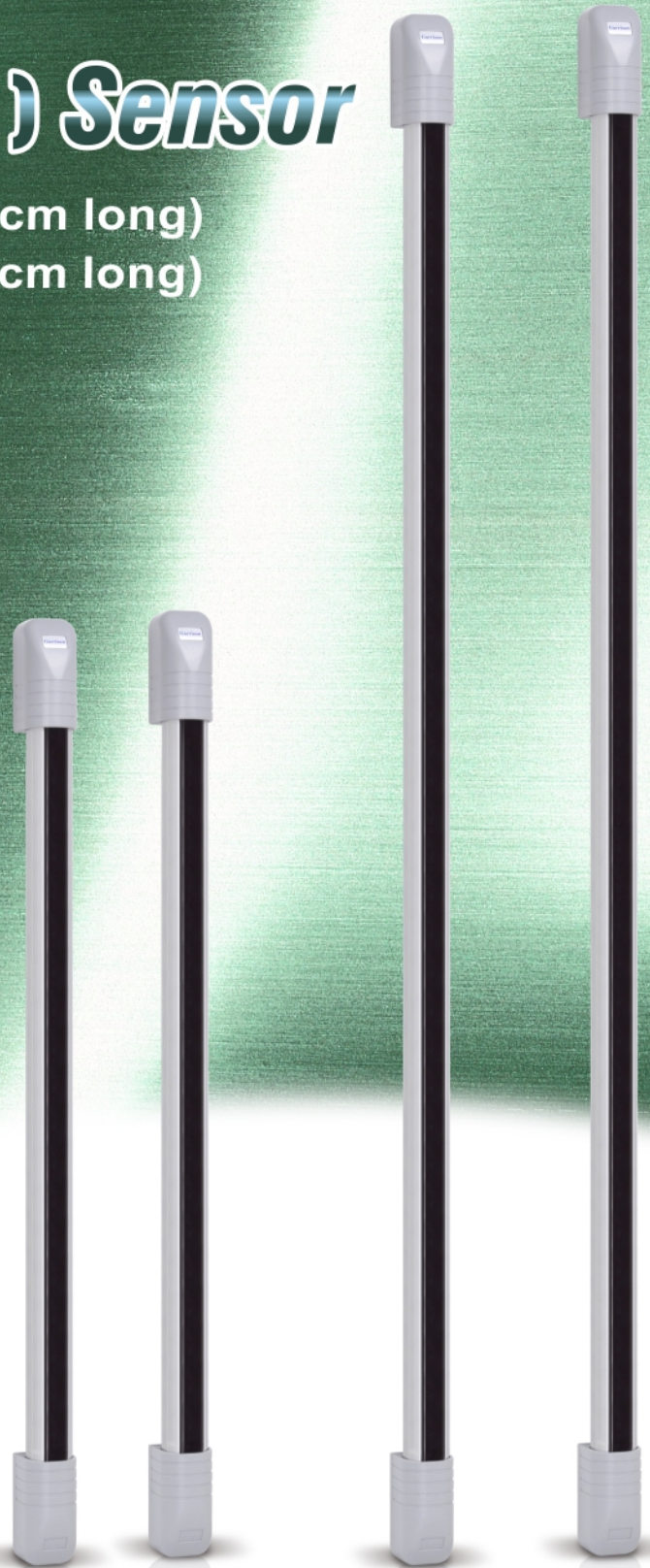



## Response time adjustment (Auto)

### LK-20HM2

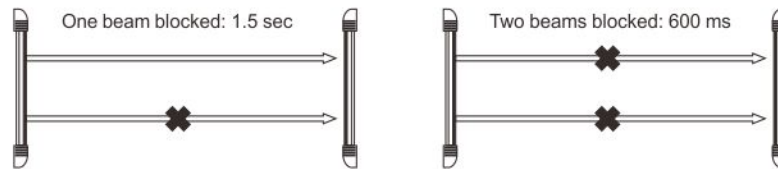

### LK-20HM4

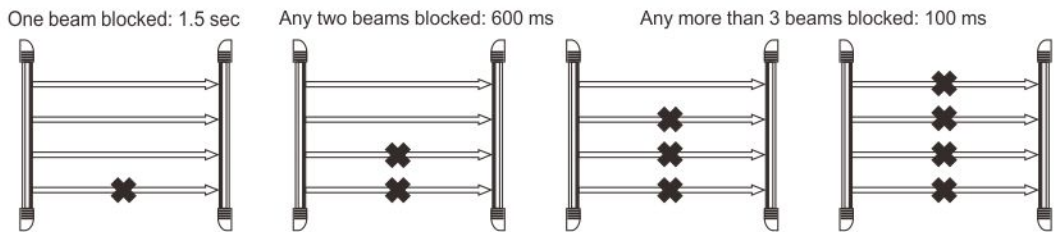

\* Note: LK-20HM2, LK-20HM4 can automatically adjust response time corresponding to the number of beam blocked.

## Wiring

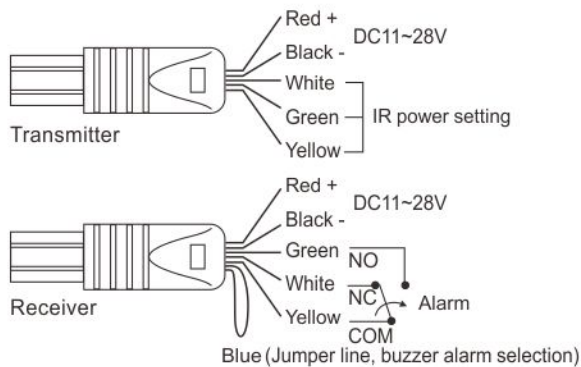

Installation distance	<5m	<10m	≥10m
IR power setting	White/Black short	Green/Black short	Yellow/Black short
	Black  White	Black  Green	Black  Yellow

Jumper (Blue line)	
Cut jumper	Buzzer alarm removed for beam alignment
Short jumper	Buzzer alarm for beam alignment

## Dimensions

Unit: mm

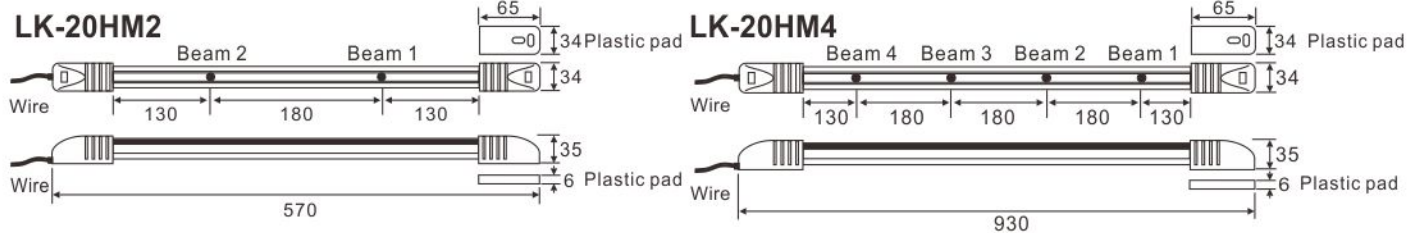

## Specification

Model	LK-20HM2	LK-20HM4
Number of Beams	2	4
Detection Range	Outdoor: 20 m	
Supply Voltage	DC 11V~28V	
Current (DC12V)	55mA	80mA
LED Indicator	Good: alignment LED beam 1~2 off. Beam blocked: beam LED ON. Readjustment: beam LED blinks Alarm: Alarm LED ON	Good: alignment LED beam 1~4 off. Beam blocked: beam LED ON. Readjustment: beam LED blinks Alarm: Alarm LED ON
Response Time	600 ms / 1.5 sec (Auto)	100 ms / 600 ms / 1.5 sec (Auto)
Alarm Output	Dry contact relay output 1C, Contact action: 1±0.5 sec, Contact capacity: 30V (AC/DC) 1A or less	
Temperature	-25°C ~ +60°C	
Beam Adjustment	180° (±90° right / left)	
Mounting Site	Outdoor, indoor wall or window frame (Town house, apartment complex, luxury villa etc.)	
Dimensions (mm)	H570 x W34 x D35	H930 x W34 x D35
Weight	Tx: 295g, Rx: 305g	Tx: 490g, Rx: 510g
IP Rating	IP 66	
Materials	Aluminum, PC resin	
Accessories	Tapping screw x 4pcs, plastic pad x 4pcs	

\* Caution: Above specification is subject to change without prior notice for improvement