

Infrared Photobeam Sensor

Digital Twin-Beam

LK-20HD(20m)

LK-35HD(35m)

LK-70HD(70m)

LK-90HD(90m)



Pole Mount (Outdoor)

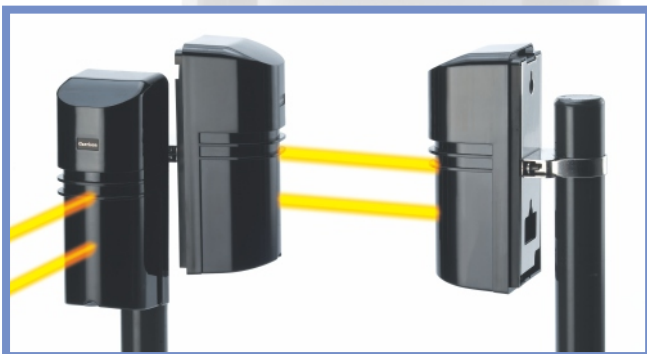

LED level meter for beam alignment. Two LEDs on the receiver act as a level meter to visually display the beam reception level. 7-level LED indicator enables quick and accurate beam alignment.

Features:

1. Powerful and reliable twin beam detector.
2. Easy optical alignment with LED indication.
 - ◎7-level LED indicator, we can check beam strength easily.
 - ◎Highly accurate alignment, no need to use voltmeter.
 - ◎No need for using beam blocking plate.
3. Double modulation synchro-twin beam (20KHz/500Hz).
4. Adjustable beam interruption period (50-700msec).
5. Lighting & surge protection. Automatic gain control circuit.
6. Form C relay providing more applications.
7. Anti-Frost design.
8. IP rating up to 66, made possible by the high-sealing silicone rubber packing.
9. Target color, structure colors, is tuned to the peak wavelengths of human vision, to be easily targeted in the beam alignment process.

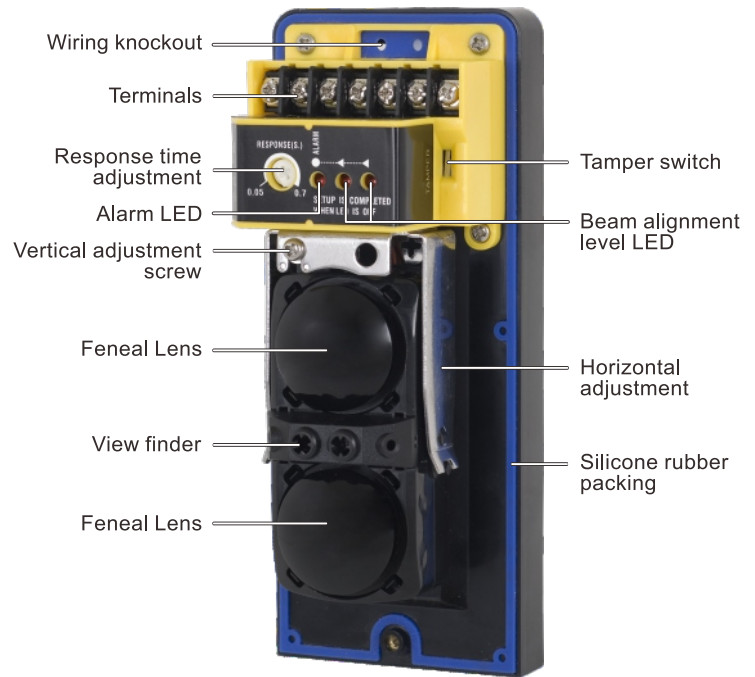

Dimensions

Wall mount

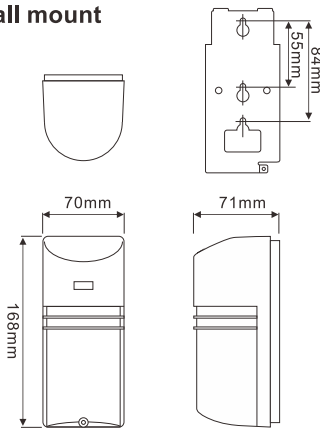

Pole mount

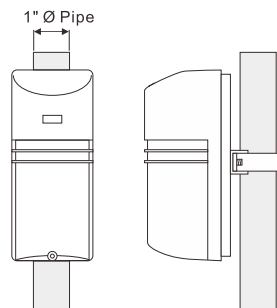

Detection Range

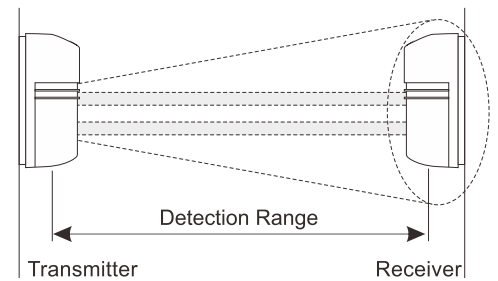

LK-20HD	LK-35HD	LK-70HD	LK-90HD
20m	35m	70m	90m

Specification

MODEL	LK-20HD	LK-35HD	LK-70HD	LK-90HD
Coverage outdoor use	20m	35m	70m	90m
Detection method	Pulse infrared 20KHz/500Hz double modulation			
Interruption period	50~700msec (variable)			
Power input	11~30VDC (no polarity)			
Power Consumption (at 12VDC input)	45 mA	55 mA	60 mA	70 mA
Indication LED	Power LED: GREEN LED(transmitter) ALARM LED: RED LED (receiver) BEAM alignment level LED: 2 RED LEADS (receiver)			
Alarm duration	1 ± 0.5 Sec (nominal)			
Relay output	Form C relay, dry contact 1A/120VAC, 2A/24VDC (resistor load)			
Tamper	Opens when cover is removed (1A/120VAC)			
IP rating	IP66			
Alignment angle	Vertical 20° (±10°), Horizontal 180° (±90°)			
Mounting	Wall mount or pole mount			
Operation Temperature	-25°C ~ +60°C			
Weight	690g			
Accessories	Tapping screw (4pcs), Metal mounting bracket (2pcs)			

■ The specification are subject to change without notice.

Terminals

Transmitter

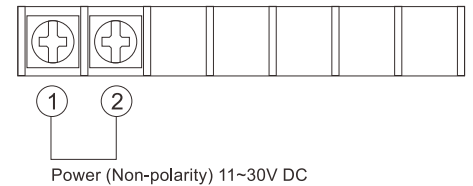

Receiver

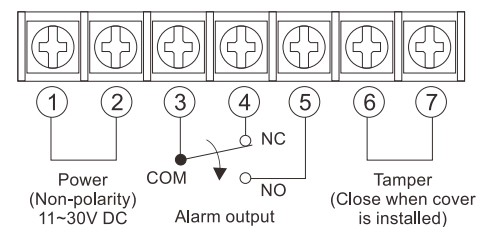

■ Option Parts: (For Pole mounting)

U-clamp x 2 pcs, Mounting hook x 2 pcs, Screw(4Øx12) x 4pcs